



04-1 Concealed Cup Hinges
P. 056-063

04-2 Wide-open Hinges
P. 064-067

04-3 Easy-on Hinges
P. 068-070

04-4 Cylinder Hinges
P. 071-073

04-5 Butt Hinges
P. 074-082

04-6 Pivot & Flap Hinges
P. 083-084

04-7 Lid Supports & Stays
P. 085-089

04-1 Concealed Cup Hinges

105° or 95° Concealed Cup Hinge - Clip on type

- * Drilling: Ø35mmxdepth 11.5mm
- * 45mm or 52mm C.C.
- * Material: steel

* Full overlay

F	H	2	4
3	17	15	
4	18	16	
5	19	17	
6	20	18	

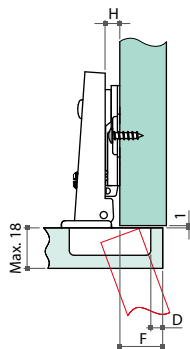

Item No.	Door opening angle
U2711	105°
U2712	95°

* Half overlay

F	H	2	4
3	8	6	
4	9	7	
5	10	8	
6	11	9	

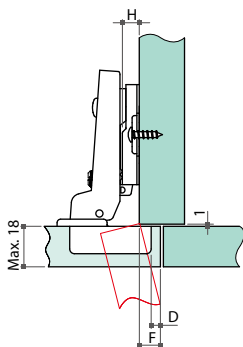

Item No.	Door opening angle
U2715	105°
U2716	95°

* Inset

L	H	4
3	2	
4	1	
5	0	

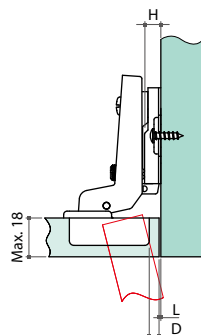

Item No.	Door opening angle
U2718	105°
U2719	95°

04-1 Concealed Cup Hinges

30°, 45° or 90° Concealed Cup Hinge - Clip on type

- * Ø35mm cup hinge
- * Material: zinc die casting
- * Finish: nickel plated
- * Spring loaded self-closing
- * Maximum door thickness: 21 mm

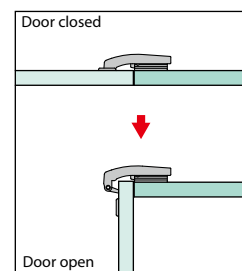

30° corner cabinet

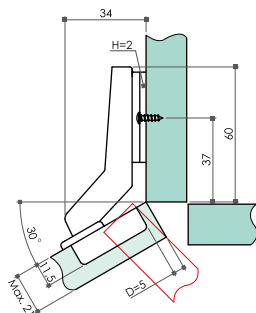

Item No.	Hinge type	Door opening angle
U2726	30°	105°

45° corner cabinet

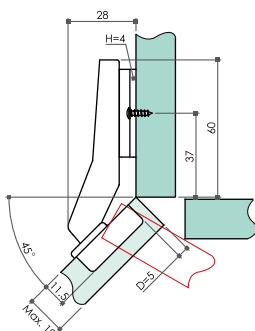

Item No.	Hinge type	Door opening angle
U2727	45°	105°

90° blind corner cabinet

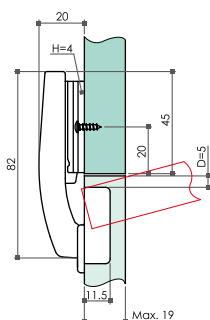

Item No.	Hinge type	Door opening angle
U2728	90°	105°

04-1 Concealed Cup Hinges

U2729 Pie-cup Corner Hinge - Clip on type

- * Ø35mm cup hinge
- * Zamak arm, nickel plated

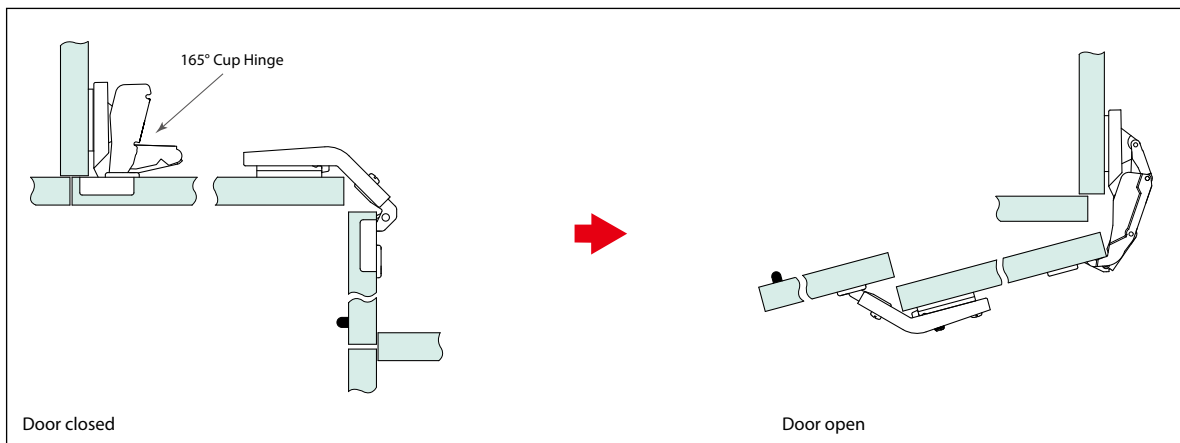
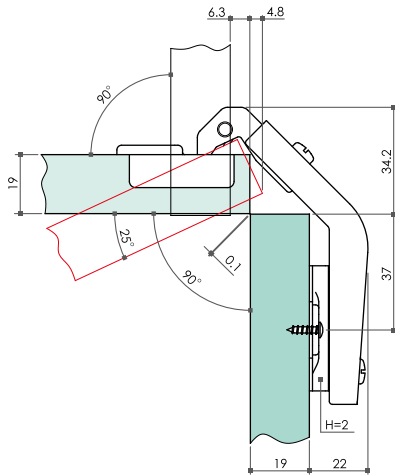

04-1 Concealed Cup Hinges

Aluminium Frame Door Hinge - Clip on type

* Material: zinc die casting cup

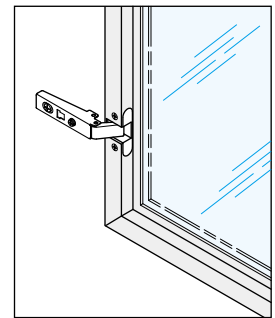

* Full overaly

F	H	2	4
18	15	13	
19	16	14	
20	17	15	
21	18	16	

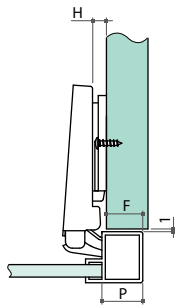

Item No.	Door opening angle
U2745	95°

* Half overaly

F	H	2	4
18	7	5	
19	8	6	
20	9	7	
21	10	8	

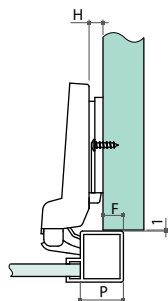

Item No.	Door opening angle
U2747	95°

* Inset

L	H	4
18	1	
19	0	

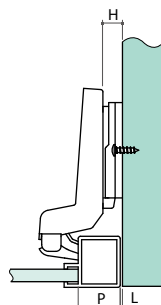

Item No.	Door opening angle
U2748	95°

04-1 Concealed Cup Hinges

180° Concealed Cup Hinge - Clip on type

- * Ø35mm cup hinge
- * Finish: nickel plated
- * Spring loaded self-closing

Full overaly door

- * Material: steel

F	H	2	4
3	14	12	
4	15	13	
5	16	14	
6	17	15	
7	18	16	

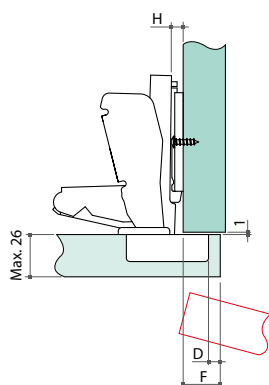

Item No.	Door opening angle
U2735	180°

Half overal

- * Material: zinc die casting

F	H	2	4
3	7	5	
4	8	6	
5	9	7	
6	10	8	
7	11	9	

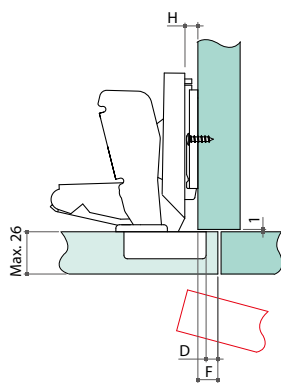

Item No.	Door opening angle
U2737	180°

04-1 Concealed Cup Hinges

Mounting Plate for Clip on Hinge

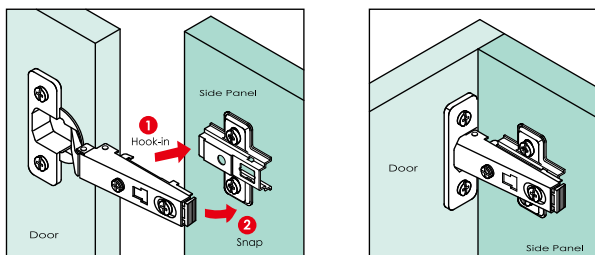

* Chipboard screw

Item No.	Height (H)	Mounting method
UMT202	2	chipboard screw
UMT204	4	

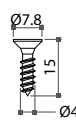
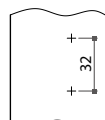
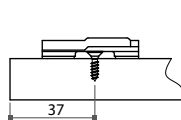

* Chipboard screw (with 4 screw holes)

Item No.	Height (H)	Mounting method
UMT253	3	chipboard screw (with 4 screw holes)

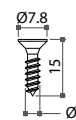
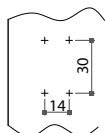
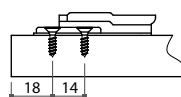

* Premounted with Euro screws

Item No.	Height (H)	Mounting method
UMT212	2	premouted with Euro screws
UMT214	4	

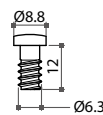
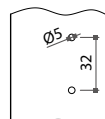
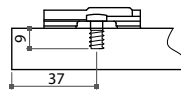

* Premounted with wood screws

Item No.	Height (H)	Mounting method
UMT232	2	premouted with wood screws
UMT234	4	

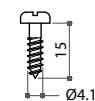
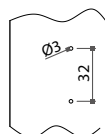
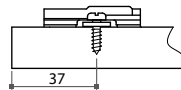

* Ø5mm nylon expansion nut fixing

Item No.	Height (H)	Mounting method
UMT222	2	Ø5mm nylon expansion nut fixing
UMT224	4	

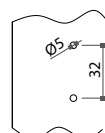
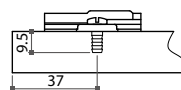

04-1 Concealed Cup Hinges

Mounting Plate With Vertical Adjustment ($\pm 2\text{mm}$) For Clip on Hinge

* Chipboard screw (with 3 screw holes)

Item No.	Height (H)	Mounting method
UMT262	2	chipboard screw (with 3 screw holes)
UMT264	4	
UMT266	6	

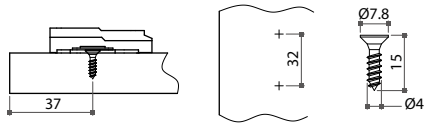

* Chipboard screw (with 4 screw holes)

Item No.	Height (H)	Mounting method
UMT272	2	chipboard screw (with 4 screw holes)
UMT274	4	
UMT276	6	

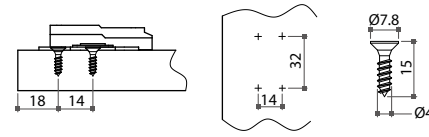

Cup Hinge Accessories

SC100 Steel Cover

* For $\text{\O}35\text{mm}$ cup hinge, nickel plated

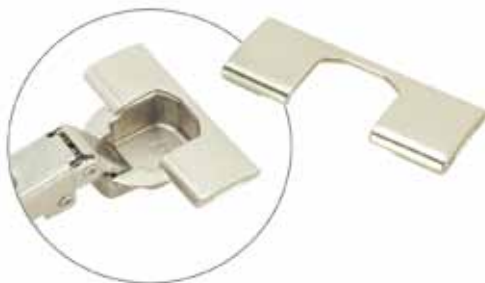

Hydraulic Soft-Closing Damper



D100
* For full overlay



D200
* For half overlay or inset

PT100 Push-to-Open Hinge

* With plastic push latch and square or round strike

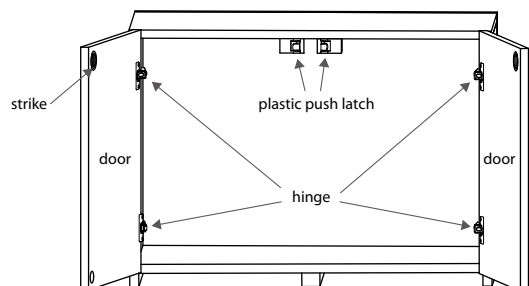

04-1 Concealed Cup Hinges

Ø26mm Face Frame Concealed Hinge

- * Ø26mm cup hinge, 10.7mm depth
- * 105° door opening angle
- * Steel, nickel plated
- * Spring loaded self-closing
- * Three dimensions of adjustment

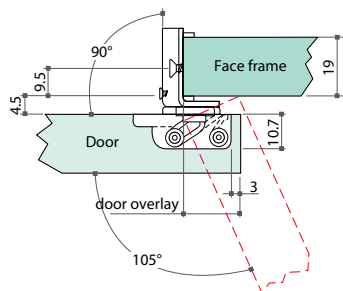
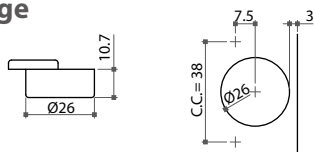

Item No.	Door overlay
27264	1/2"
27265	5/8"

Ø35mm Face Frame Concealed Hinge

- * Ø35mm cup hinge, 10.7mm depth
- * 105° door opening angle
- * Steel, nickel plated
- * Spring loaded self-closing
- * Three dimensions of adjustment

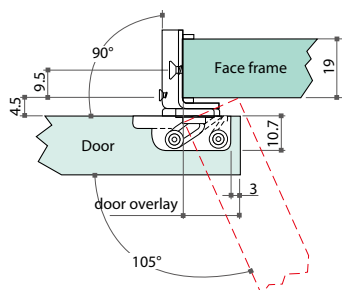
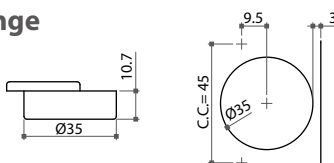

Item No.	Door overlay
27354	1/2"
27355	5/8"

Face Frame Concealed Hinge

- * Ø35mm cup hinge, 11.5mm depth
- * 95° door opening angle
- * Steel cup, zamak crank, nickel plated
- * Spring loaded self-closing
- * Mounting type: slide on

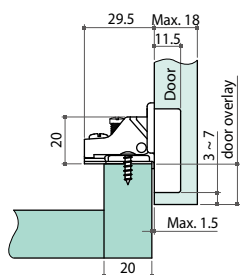
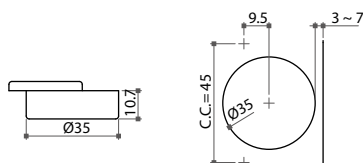

Item No.	Door overlay
22854	5/8"
22855	1/2"

04-2 Wide-Open Hinges

22740 Wide Angle Single Pivot Hinge

- * 270° opening angle and 15.5mm door overlay
- * Side panel mounting
- * Zamak, nickel plated, with spring catch
- * Complete with two plastic covers and one 3mm spacer

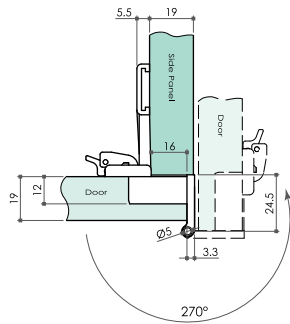
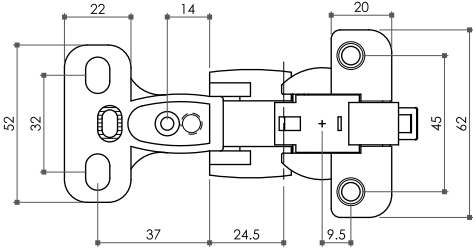

Item No.	Door opening angle
22740	270°

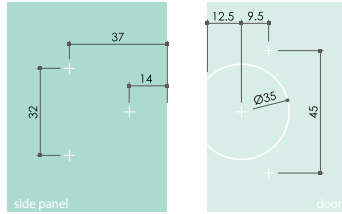

22770 Wide Angle Single Pivot Hinge

- * 230° opening angle and 6.5mm door overlay
- * Side panel mounting
- * Zamak, nickel plated, with spring catch
- * Available with nylon dowels (Ø10mm) for hinge cup mounting plate and press-in expansion (Ø5mm) for adjustment

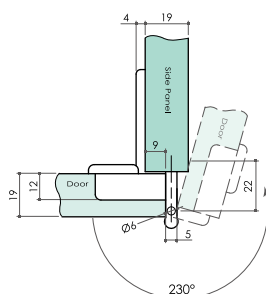
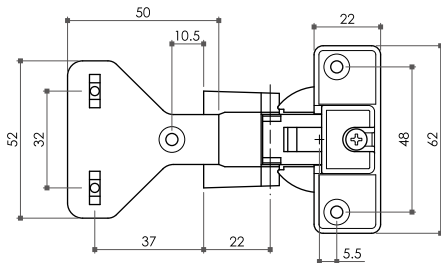

Item No.	Door opening angle
22770	230°

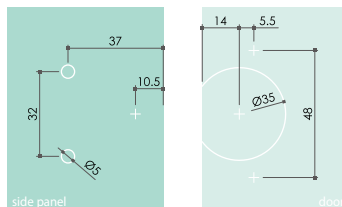

04-2 Wide-Open Hinges

22775 Wide Angle Single Pivot Hinge

- * 270° opening angle and 15mm door overlay
- * Side panel mounting
- * Zamak, nickel plated, with spring catch
- * Available with nylon dowels (Ø10mm) for hinge cup mounting plate and press-in expansion (Ø5mm) for adjustment

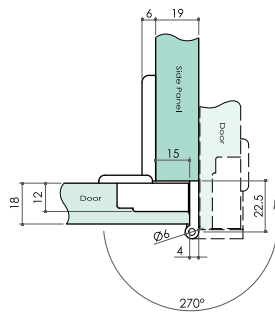
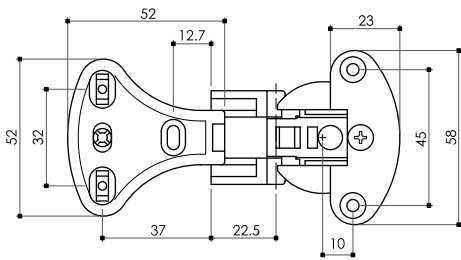
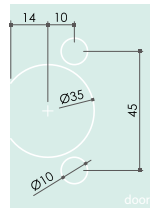
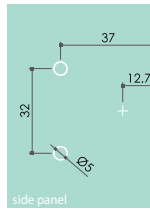

Item No.	Door opening angle
22775	270°



22772 Wide Angle Twin Pivot Hinge

- * 180° opening angle and 6.5mm door overlay
- * Twin doors mounting
- * Zamak, nickel plated, with spring catch
- * Available with nylon dowels (Ø10mm) for hinge cup mounting plate and press-in expansion (Ø5mm) for adjustment

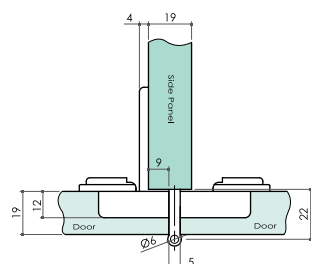
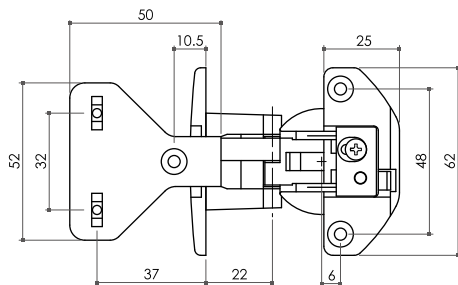
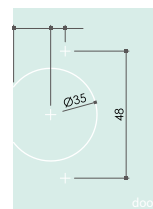
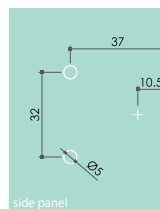

Item No.	Door opening angle
22772	180°



04-2 Wide-Open Hinges

Exposed Knuckle Offset Hinge

- * 240° opening angle and 3.5mm door overlay
- * Zamak, nickel plated or black coating, with spring catch
- * Hardened steel axle with nylon ring for smooth swinging

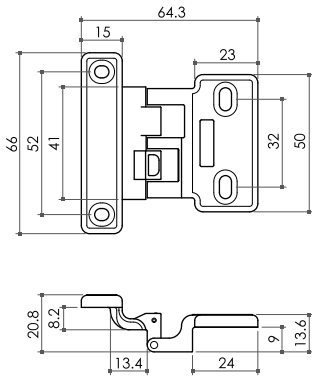
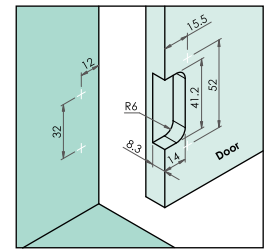
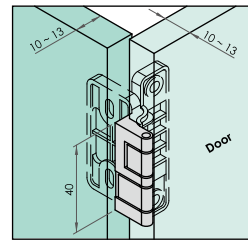

Item No.	Type
22745	with spring catch
22746	without spring catch

Institutional Hinge

- * 270° opening angle
- * Material: 2.5mm thickness steel
- * Electro plated: satin chrome, satin nickel, polished brass or chrome
- * Powder coated: black, matt silver gray or pearl gray

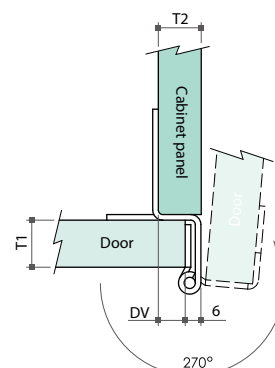
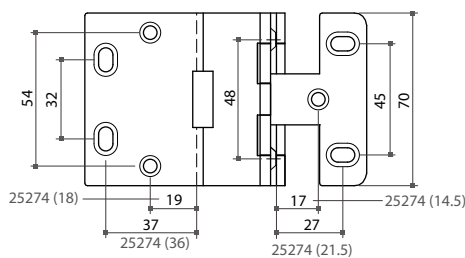

Item No.	Door thickness (T1)	Cabinet thickness (T2)	Door overlay (DV)
25270	21mm	19mm	
25271	21mm	19mm	14mm
25272	21mm	21mm	
25273	21mm	16mm	
25274	29mm	16mm	for inlay door

04-2 Wide-Open Hinges

Economic Wide-Open Knuckle Hinge

- * 270° opening angle
- * Material: 1.8mm thickness steel, zinc, bright brass and bronze plated
- * Mounting type: screw-in fixing

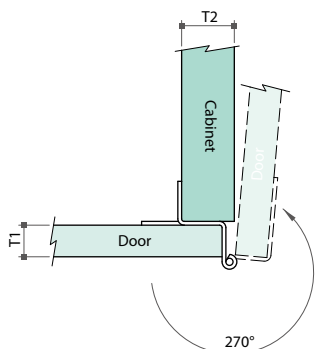

Item No.	Door thickness (T1)	Cabinet thickness (T2)	Door overlay (DV)
25260	19mm	19mm	18.5mm
25261	19mm	21mm	20.5mm

20615 Crank Hinge

- * 1.6mm thickness
- * Steel, bright, bronzed or antique brass plated

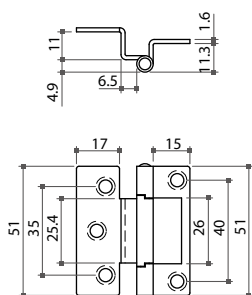

Item No.	Thickness
20615	1.6mm

25220 Crank Hinge

- * 1.8mm thickness
- * Steel, bright, bronzed brass or nickel plated

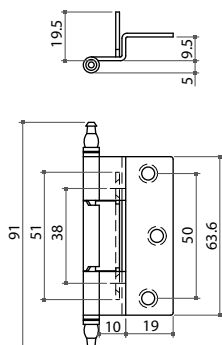

Item No.	Thickness
25220	1.8mm

04-3 Easy-On Hinges

22316 Easy-On Hinge

- * 90° opening angle
- * Spring loaded self-closing
- * No drilling hole required
- * Available also in stainless steel

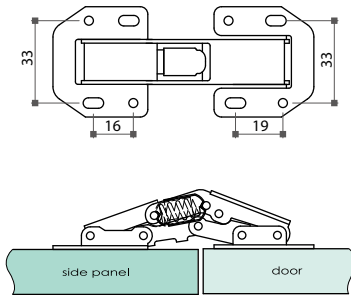

Item No.	Material
22316	steel, nickel plated
22316SS	stainless steel

22315 Easy-On Hinge

- * 150° opening angle
- * Steel, nickel plated
- * Spring loaded self-closing
- * No drilling hole required

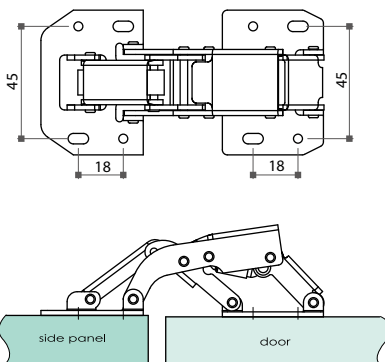
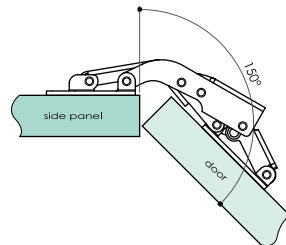

Item No.	Material
22315	steel, nickel plated

04-3 Easy-On Hinges

22318 Adjustable Easy-On Hinge

- * Maximum 150° opening angle
- * Steel, nickel plated
- * Spring loaded self-closing
- * No drilling hole required

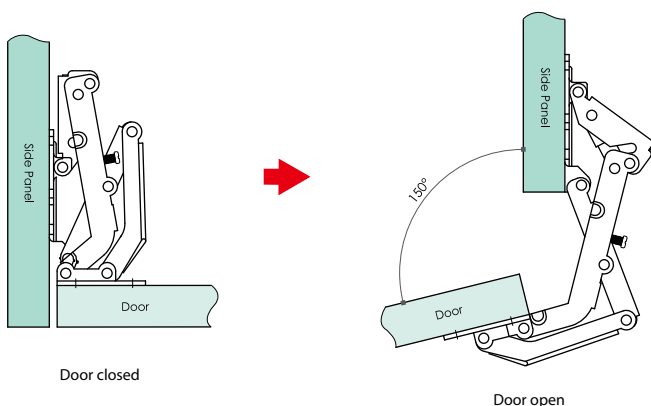
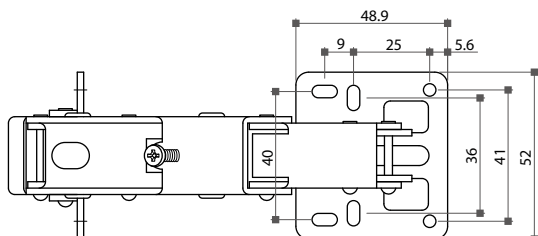

Item No.	Material
22318	steel

22319 Easy-On Hinge With Lid Support

- * 90° opening angle
- * Steel, nickel plated
- * Spring loaded self-closing
- * No drilling hole required
- * From 16mm face frame door

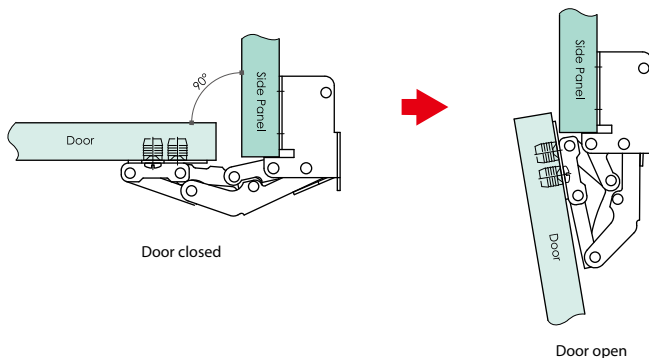
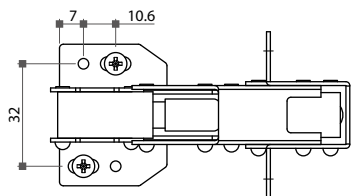

Item No.	Material
22319	steel

04-3 Easy-On Hinges

22317 Easy-On Hinge With Side-Mount Bracket

- * 70° opening angle, $\pm 5^\circ$ adjustable
- * To be installed on sink-front lid door
- * Steel, nickel plated, with one set of white powdered bracket
- * Spring loaded self-closing
- * Also available in stainless steel

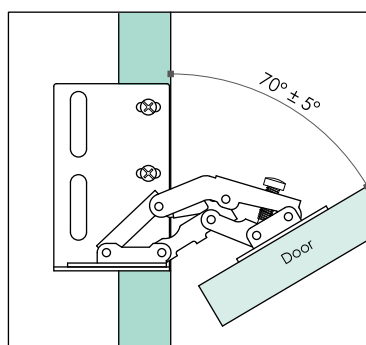
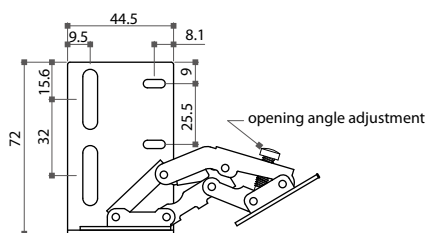
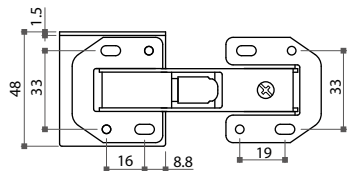

Item No.	Material
22317	steel

Sink Front Tip-Out Tray

- * #304 stainless steel tray, film protected, with two key holes
- * Make use of kitchen sink front to store sponges and cleaners

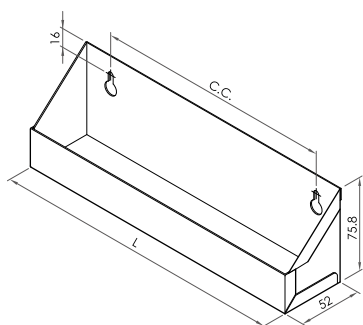

Item No.	C.C.	L
A81011	194mm	238mm
A81012	244mm	290mm
A81013	320mm	366mm

04-4 Cylinder Hinges

SOS Invisible Hinge

- * 180° opening
- * Material: zinc alloy & stainless steel #304
- * Finish: polished chrome, satin chrome, satin nickel or brass



21100



21101



21104



21102

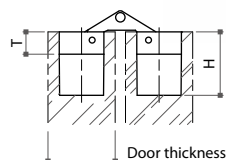
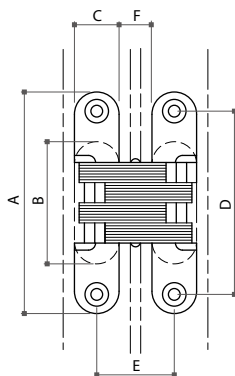

unit: mm

Item No.	A	B	C	D	E	F	T	H	Door thickness	Screw dia.
21100	44.5	18.5	12.6	31.6	21.9	9	4.8	18	18 ~ 20	Ø4.5
21101	60	31.4	12.9	47.5	22	9	6.1	18	19 ~ 21	Ø4.5
21104	70	34	16	52.6	26.6	10	6.9	23	22 ~ 26	Ø4
21102	94	52	19	78	33	14	9.5	27	25 ~ 32	Ø5
21103	117	63	25	91	43	18	12	31	34 ~ 42	Ø6

04-4 Cylinder Hinges

Solid Brass Cylinder Hinge

- * 180° opening concealed hinge
- * Finish: bronze, nickel, satin chrome and black plated

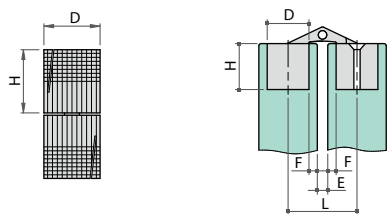
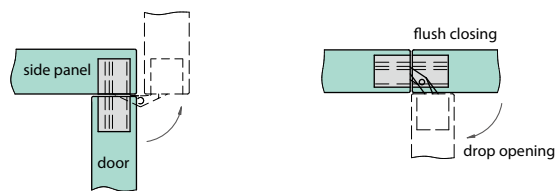
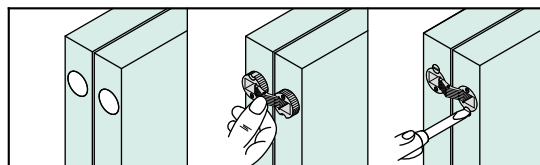

unit: mm

Item No.	D	H	L	E	F
20571	Ø10	11.0	16.5	2.5	2.0
20572	Ø12	13.5	20.0	3.5	2.2
20573	Ø14	15.5	23.0	3.0	3.0
20574	Ø16	16.5	25.0	3.0	3.0
20575	Ø18	17.5	27.0	3.0	3.0
20576	Ø24	25.0	36.5	4.5	4.0



Solid Brass Concealed Hinge

- * 180° opening concealed hinge
- * Finish: nickel, satin chrome and black plated
- * Fixed with chipboard screws straightly or obliquely

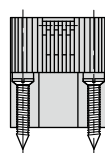

straight screw fixing

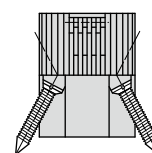

oblique screw fixing

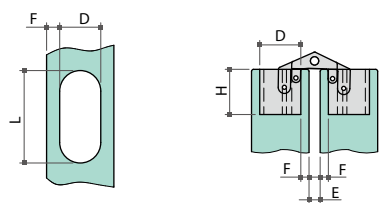
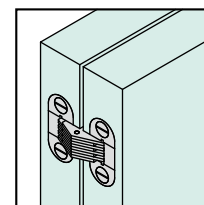

unit: mm

Item No.	D	H	L	E	F
21571B	Ø12	15.5	24	2	3
21572S	Ø12	15.5	27	2	3
21572B	Ø12	15.5	27	2	3



04-4 Cylinder Hinges

22890 Mortise Nylon Hinge

- * Material: plastic housing in brown or white
- * Metal hinge arm in nickel plated
- * Ø25mm and 14mm depth drilling hole

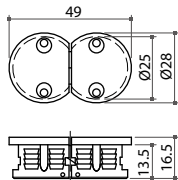

Item No.	Drilling hole size
22890	Ø25x14mm depth

22886 Flap Hinge

- * Material: zinc alloy
- * Finish: nickel or antique copper plated

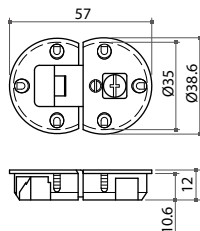
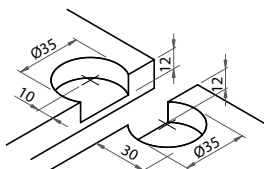

Item No.	Drilling hole size
22886	Ø35x12mm depth

22903 Flap Hinge

- * Material: zinc alloy with plastic
- * Finish: nickel, brass or antique English plated with brown

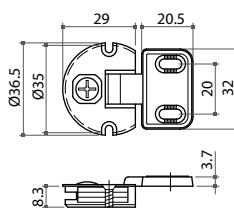
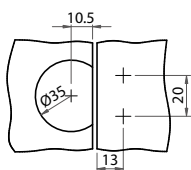

Item No.	Drilling hole size
22903	Ø35x8.3mm depth

22880 Flap Hinge

- * Material: zinc alloy with plastic
- * Finish: nickel or brass plated with black

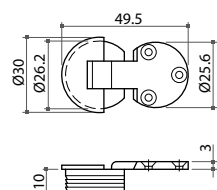
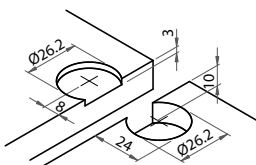

Item No.	Drilling hole size
22880	Ø26.2x10mm depth

04-5 Butt Hinges

Butt Hinge

- * Material : steel or stainless steel
- * Finish: zinc plated, brass plated, antique brass & antique copper

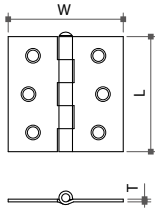

Item No.	Dimension (LxWxT)	Screw hole
21510	100x100x2.3mm	#8
21511	89x89x2.3mm	#8
21512	76x76x2.0mm	#8
21513	64x64x2.0mm	#8
21514	51x51x1.2mm	#5
21515	38x38x1.0mm	#4

Metric Butt Hinge

- * Material : steel or stainless steel
- * Finish: zinc plated, original color

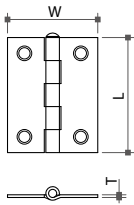

Item No.	Dimension (LxWxT)	Screw hole
21520	100x100x2.5mm	#9
21521	100x75x1.6mm	#7
21522	85x60x1.6mm	#7
21523	70x50x1.6mm	#6
21524	50x40x1.2mm	#5
21525	35x25x1.0mm	#4

21535 Radius Hinge (1/4" Radius)

- * Material : steel
- * Finish: zinc plated, galvanized

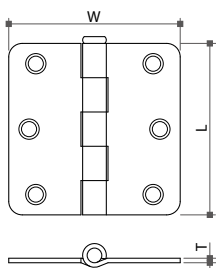

Item No.	Dimension (LxWxT)	Screw hole
21535	76x76x2.0mm	#8

04-5 Butt Hinges

21050 180° Bi-Fold Hinge

- * Material: zamak
- * Finish: black
- * Spring action with stops at 180°, 90° and 45°

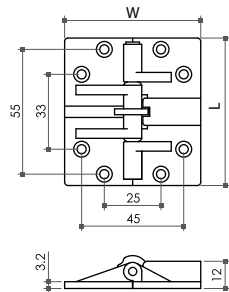

Item No.	Size (LxW)
21050	65x60mm

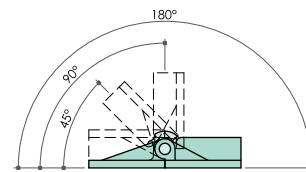

21052 180° Bi-Fold Hinge

- * Spring action with stops at 180°, 90° and 45°

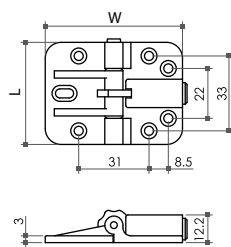

Item No.	Size (LxW)
21052	45x60.5mm

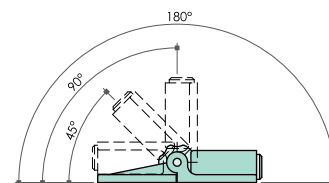

21053 90° Bi-Fold Hinge

- * Spring action with stops at 90° and 45°

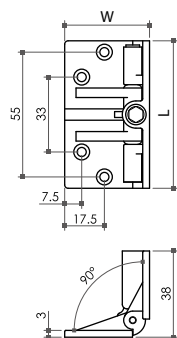

Item No.	Size (LxW)
21053	65x37.4mm

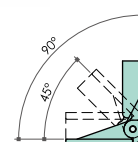

04-5 Butt Hinges

Piano Hinge

- * Material: steel or stainless steel
- * Finish: nickel plated, brass plated or original color
- * Free swing

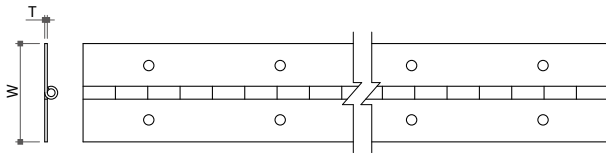

Item No.	W	T
21580	3/4"	0.8mm
21581	1-1/4"	1.0mm
21582	1-1/2"	1.0mm

Spring Piano Hinge

- * Material: steel or stainless steel
- * Finish: nickel plated, brass plated or original color

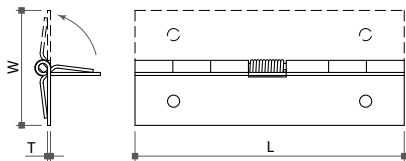

Item No.	Dimension (LxWxT)	Screw hole
21545	89x38x1.0mm	Ø4mm
21546	127x51x1.2mm	Ø4.7mm

Bar Joint Hinge

- * Material: steel
- * Finish: black coated

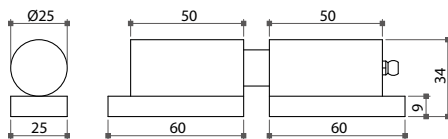

Item No.	Dimension
21540	127x25.4mm
21541	178x15x38mm

04-5 Butt Hinges

"H" Hinge

- * Flush type, scalloped edge
- * Finish: black, antique brass or antique copper

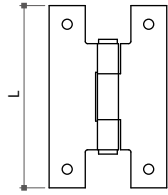

Item No.	L
20522	2-1/2" (with 4 holes)
20523	3" (with 6 holes)

Ornamental Cabinet Hinge

- * Steel, brass, chrome, nickel, bronze or black plated
- * Available with fixed pin: flush type
- * Also available in solid brass

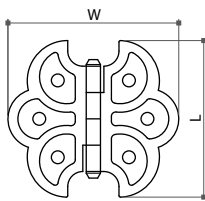

Item No.	Size (LxW)
20190	55x60mm
20193	36x49mm

Folding Door Butt Hinge

- * Available with fixed pin: flush type
- * Steel, zinc, bronze or black plated
- * For folding door fittings

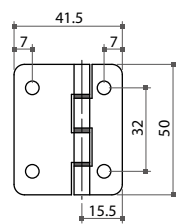

Item No.	Feature
25900	screw holes
25900A	Ø8mm nylon dowels

Back Flap Hinge

- * Material: steel
- * Finish: zinc plated or brass plated

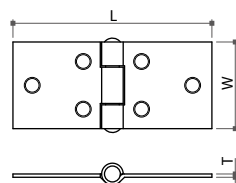

Item No.	Dimension (LxWxT)	Screw hole
21530	4-1/2"x2"x2.3mm	#9
21531	3-1/2"x1-1/2"x1.8mm	#6
21532	2-7/8"x1"x1.8mm	#5

04-5 Butt Hinges

Non-Mortise Hinge

- * Material: steel or stainless steel
- * Finish: nickel plated, brass plated or original color

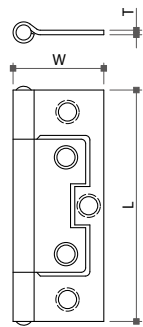

Item No.	Dimension (LxWxT)	Screw hole
21560	100.5x42x2.0mm	#8
21561	76x30x1.5mm	#6
21562	63.5x24.8x1.2mm	#5
21563	51x24x1.2mm	#4

21547 Wrap Around Hinge

- * Material : steel
- * Finish: antique copper, antique brass or brass plated

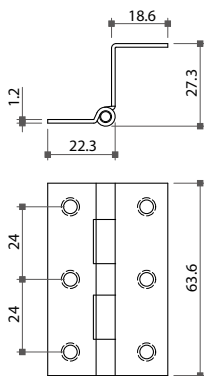

Item No.	L	Thickness	Screw hole
21547	63.5mm	1.2mm	#5

21536 Heavy Duty Welding Hinge

- * Material: steel
- * Finish: bright steel
- * With oil ring, brass washer

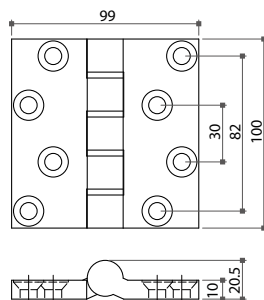

Item No.	Dimension (LxWxT)	Hole dia.
21536	100x98x10mm	Ø9mm

04-5 Butt Hinges

Folding Screen Hinge

* Steel, antique copper or brass plated

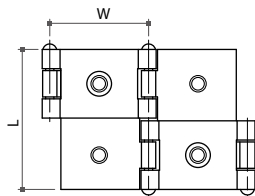
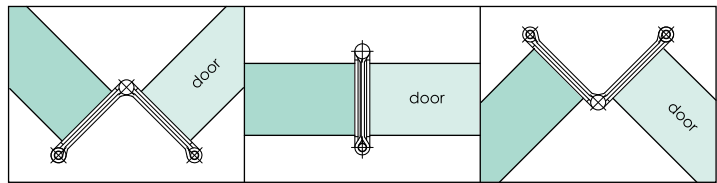

20861 / 20862 / 20864

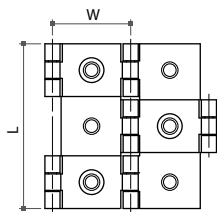

20866

Item No.	Size (LxW)	Wood thickness
20861	44.7x23mm	19mm
20862	48x30mm	25.4mm
20864	51x36mm	32mm
20866	60x28.5mm	



20861



20862



20864



20866

20240 Flush Cabinet Hinge

* Steel, antique copper, brass or zinc plated

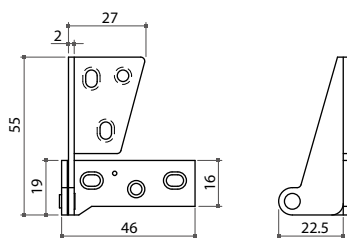

Item No.	Type
20240	for 5/8" overlay

04-5 Butt Hinges

20110 Free Swing Cabinet Hinge

- * Without spring action, free swing
- * Finish: antique brass (AB) or antique copper (AC) plated

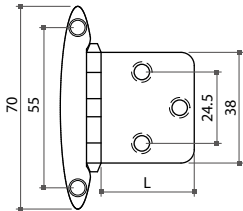
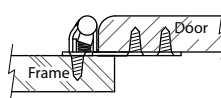

Item No.	Leaf size (L)
20110	32mm

20010 Self-Closing Hinge

- * Spring action, self-closing
- * Finish: antique brass (AB) or antique copper (AC) plated

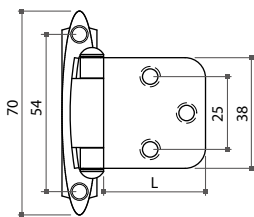
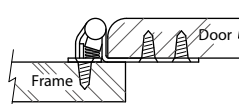

Item No.	Leaf size (L)
20010	35mm

Self-Closing Cabinet Hinge

- * Spring action, self-closing
- * Partial wrap-around, for 1/4" door overlay
- * Finish: antique brass (AB) or antique copper (AC) plated

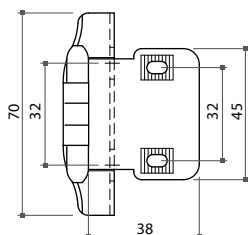
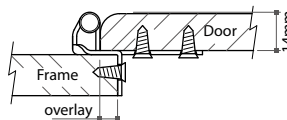

Item No.	Door overlay
20065	1/4"

04-5 Butt Hinges

Lift-Off Hinge

- * Thickness: 1.2mm
- * Steel, zinc, nickel or brass plated
- * For right or left hand door

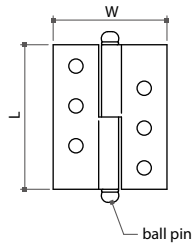

Item No.	Size (LxW)	Type
20564	50x40mm	right hand
20565	50x40mm	left hand
20561	60x43mm	right hand
20562	60x43mm	left hand
20810	100x75mm	right hand
20811	100x75mm	left hand



Lift-Off Offset Hinge

- * Thickness: 1.2mm
- * With ornamental pin
- * Steel, bronzed or antique brass plated

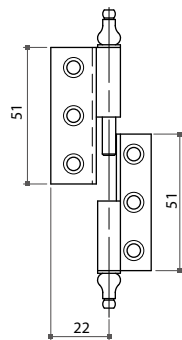

Item No.	Type
20559	right hand
20560	left hand



Lift-Off "H" Hinge

- * Thickness: 2.0mm
- * Steel, bright brass plated and other finishes

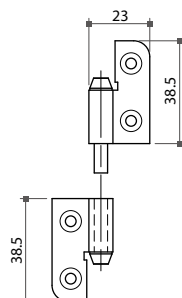

Item No.	Type
20557	right hand
20558	left hand



04-5 Butt Hinges

20251 Three Leaf Hinge

- * 1.2mm thickness
- * Steel, bright brass plated
- * With nylon washer

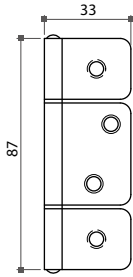

Item No.	Size (LxW)
20251	87x33mm

20673 Mon-Mortise Hinge

- * 1.4mm thickness
- * With steel ring

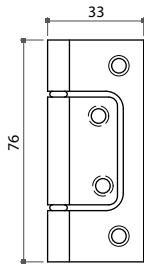

Item No.	Size (LxW)
20673	76x33mm

Hirline Hinge

- * Available with flat back or swaged type
- * Finish: antique copper, brass plated

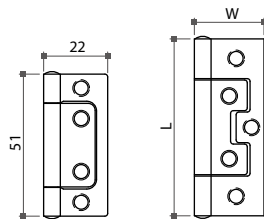

20501



Item No.	Size (LxW)	Thickness
20501	51x22mm	1.1mm
20502	63.5x25.4mm	1.3mm
20503	76x29mm	1.4mm

Cabinet Hinge

- * With minaret tip
- * Available with flat back or swaged type
- * Finish: antique copper, brass plated

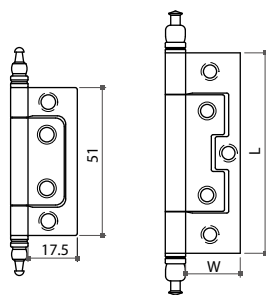

20640



Item No.	Size (LxW)	Thickness
20640	51x17.5mm	1.1mm
20641	63.5x19mm	1.3mm
20642	76x21mm	1.4mm

04-6 Pivot & Flap Hinges

20360 Pivot Hinge

- * For inset door
- * Each set consists of:
 - 1) 2 pcs of die casting back part, steel hinge, plastic bushing and flat head screw M4x6mm
 - 2) 4 pcs of wood screw 3x12mm pan head

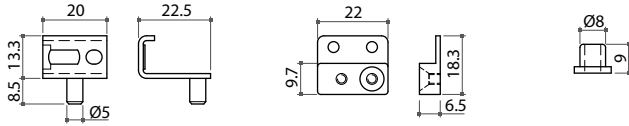
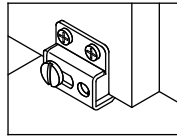

Item No.	Size
20360	20x13.3mm

Wooden Door Pivot Hinge

- * Finish: black, chrome, brass plated
- * Each set consists of:
 - 1) 1 pair of hinges (upper and lower)
 - 2) 2 pcs of plastic bushing
 - 3) 4 pcs of wood screw

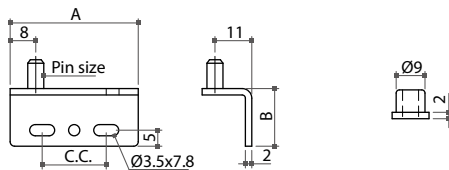

Item No.	Size (AxB)	C.C.	Pin size
21641	40x18mm	20mm	Ø5x9mm
21642	40x18mm	32mm	Ø5x9mm
21647	44x19mm	32mm	Ø5x9mm
21648	50x19mm	32mm	Ø5x9mm
21650	40x18mm	20mm	Ø4x8mm
21651	40x18mm	32mm	Ø4x8mm

21630 Wooden Door Pivot Hinge

- * Finish: black or brass plated
- * Each set consists of:
 - 1) 1 pair of hinges (upper and lower)
 - 2) 2 pcs of plastic bushing
 - 3) 4 pcs of wood screw

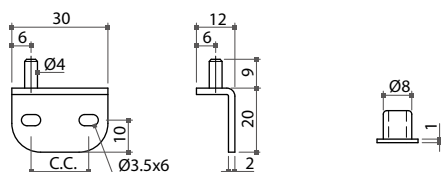

Item No.	Size	C.C.	Pin size
21630	30x20mm	18mm	Ø4x9mm

04-6 Pivot & Flap Hinges

Lift Flap Hinge

- * 75° or 90° opening adjustable
- * Material: steel
- * For kitchen lift doors, 3 screw holes fixing and two key holes for door mounting
- * Spring type can be installed on one or both sides on demand
- * Finish: white, brown, silver/RAL9006 epoxy coated or nickel, zinc plated

22361 non-spring

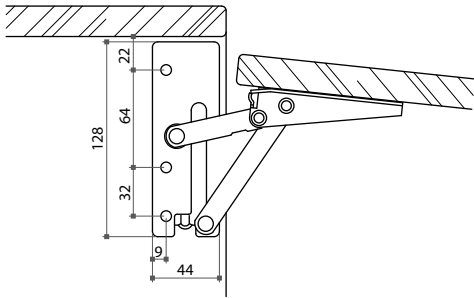

22360 with spring

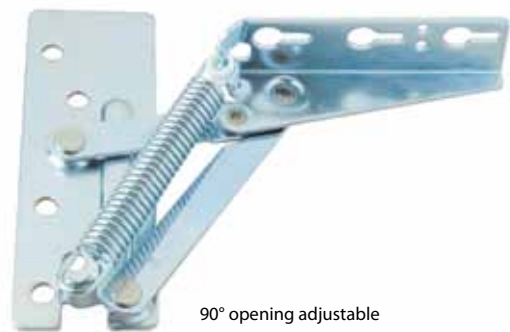
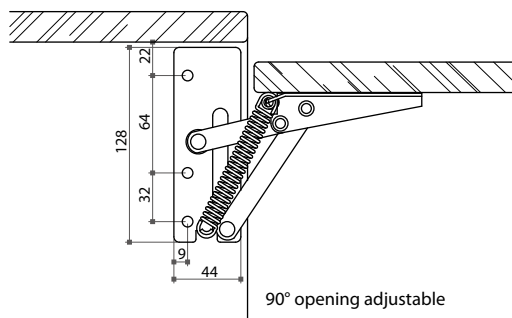
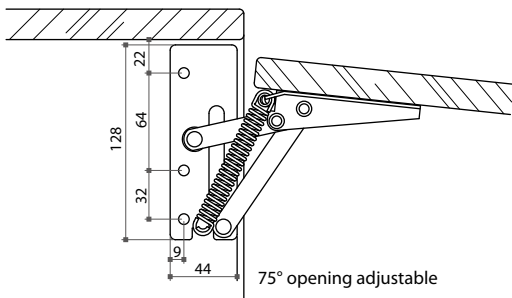

22366 with spring & adjustable screw

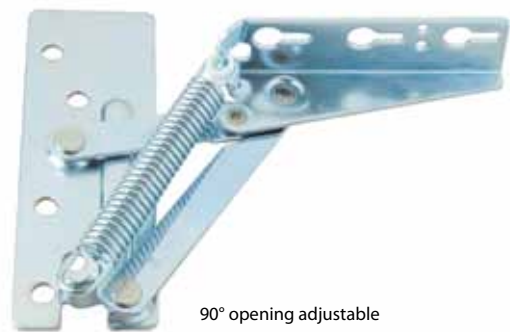
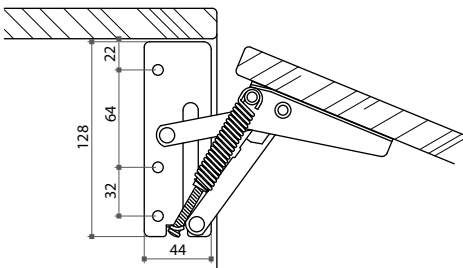

Item No.	Feature
22360	with spring
22361	no spring tension and free swing
22366	with spring and adjustable screw

04-7 Lid Support & Stay

57870 Gas Lift Mechanism

- * Easy and soft lifting from 80° to 100°
- * Firm lifting supported by gas spring of different force ranges
- * Each lift includes one pair of mounting brackets for left of right side mounting
- * Ideal for all types of overhead storage
- * Installed together with 35mm cup concealed hinges (to be ordered separately)
- * Mounting plate for aluminium door frame also available

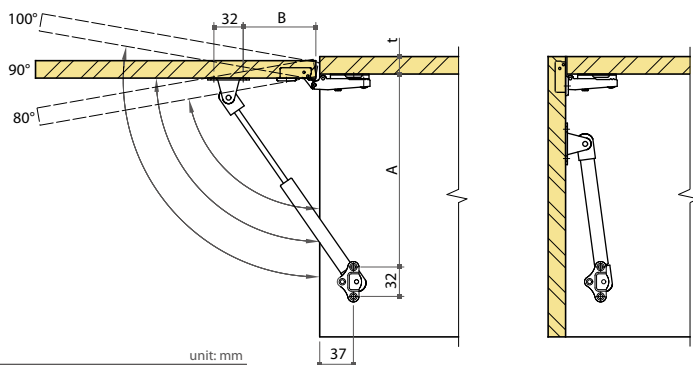

unit: mm

Opening angle	A	B
80°	238	65+t
90°	222	60+t
100°	213	52+t

Item No.	Spring force	Door material
57870-SP1	8 kgs	wooden door
57870-SP2	12 kgs	
57870AF-SP1	8 kgs	aluminium door
57870AF-SP2	12 kgs	



57875 Hydraulic Downward Mechanism

- * For downward door
- * Mounting plate for aluminium door frame also available

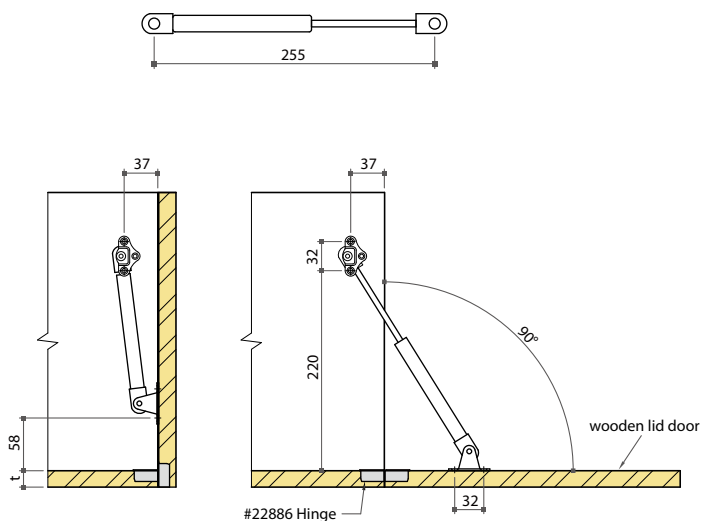

Item No.	Door material
57875	wooden door
57875AF	aluminium door



04-7 Lid Support & Stay

57890 Lid Support

- * Material: aluminium case and bar with nickel plated bracket
- * Range of length: 185 ~ 298mm
- * 32mm system fixing
- * Left or right hand mounting interchangeable

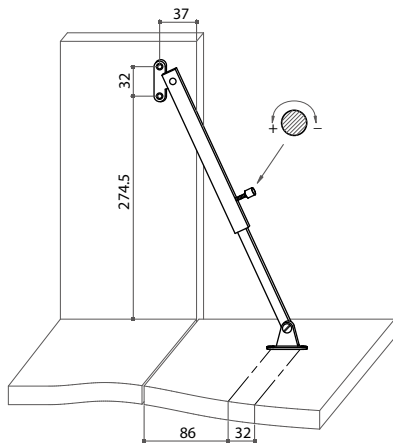

Item No.	Range of length
57890	185 ~ 298mm

57880 Econo Flap Stay

- * Rail length: 250mm
- * Plastic housing, brown or white
- * Steel rail and bracket, nickel plated

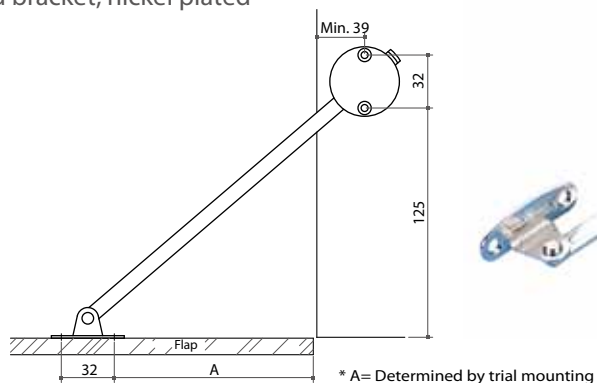

Item No.	Rail length
57880	250mm

57950 Lid Support

- * Material: steel / plastic
- * Length: 240mm
- * Finish: chrome plated
- * With mounting bracket

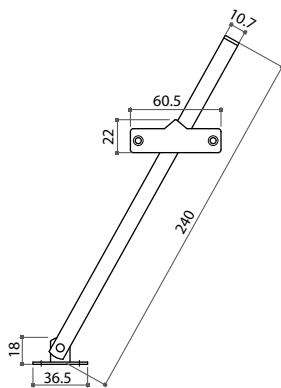

Item No.	Length
57950	240mm

04-7 Lid Support & Stay

Lid Support

- * Material: steel
- * With mounting bracket
- * Finish: chrome

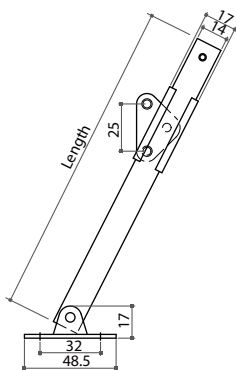

Item No.	Length
57930	168mm
57931	252mm



Lid Support

- * Material: steel
- * With mounting bracket
- * Finish: brass plated, nickel plated

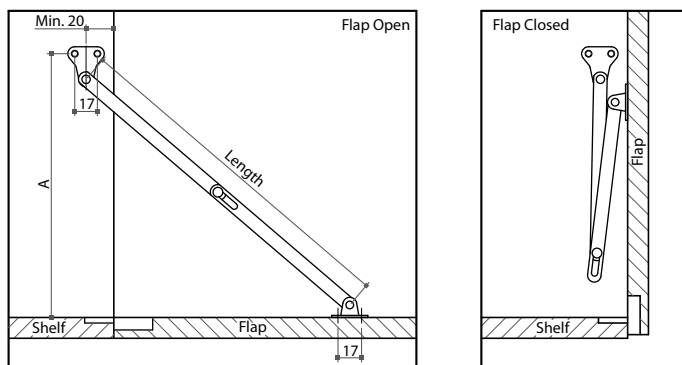

Item No.	Length	Internal case height	Distance A
57540	200mm	Min.170mm	160mm
57541	250mm	Min.200mm	190mm
57542	300mm	Min.230mm	230mm



Lid Support

- * Material: steel
- * With mounting bracket
- * Finish: brass, zinc or bronzed plated

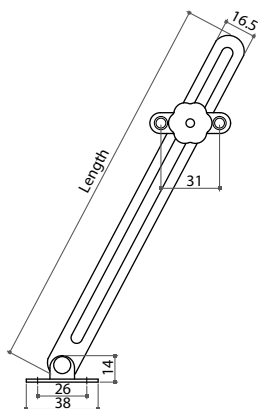

Item No.	Length
57510	254mm
57511	203mm
57512	152mm



04-7 Lid Support & Stay

Spring-Action Lid Support

- * Material: steel
- * Finish: chrome plated

57900 / 57901

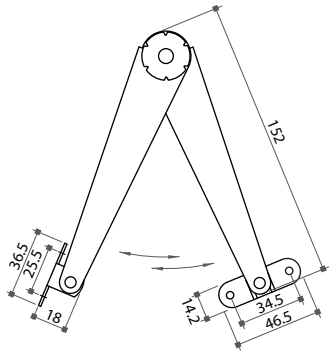

57910 / 57911

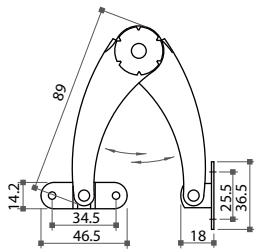

57920 / 57921

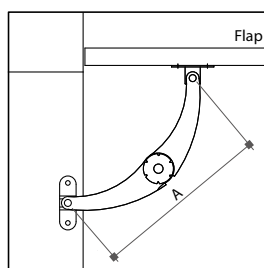
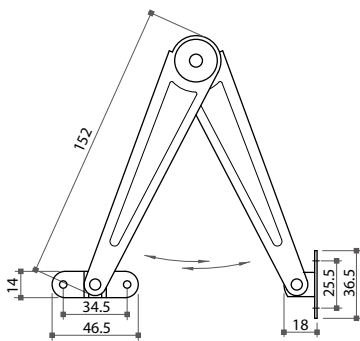

Item No.	Length	A	Type
57910	89mm	130mm	Left side
57911	89mm	130mm	Right side
57900	152mm	165mm	Left side
57901	152mm	165mm	Right side
57920	152mm	165mm	Left side
57921	152mm	165mm	Right side

04-7 Lid Support & Stay

Self-Balancing Lid Support

- * Material: steel
- * Finish: bronze or black
- * Various spring loading powers can be selected
- * Safety concern for box

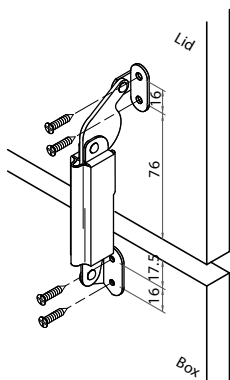

Back Mounting

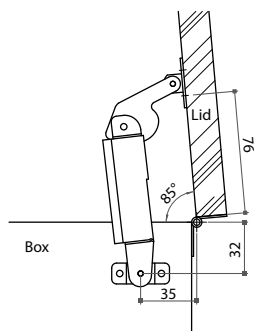

Side Mounting

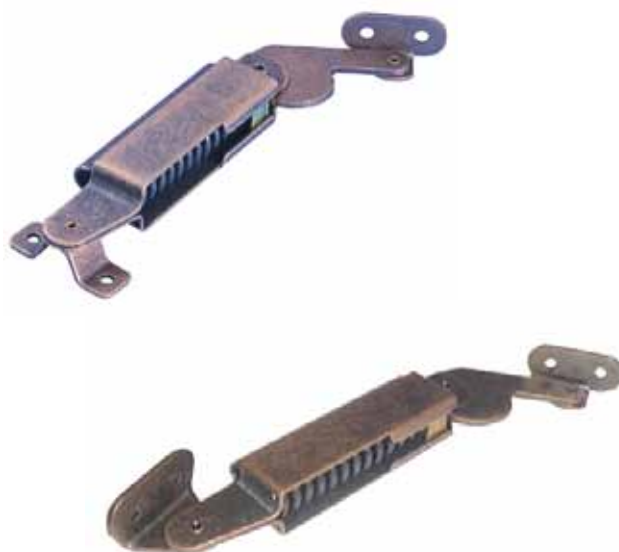

Item No.	Mounting type	Feature
57591	side	left hand
57592	side	right hand
57593	back	left hand
57594	back	right hand
57594E	back	extended spring
57594D	back	double

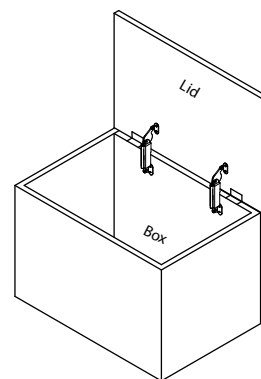
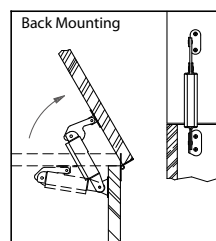
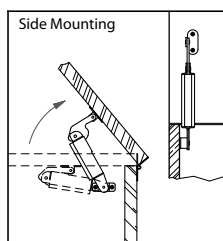

57597 Self-Balancing Lid Support With Double Springs

- * Material: steel
- * Spring size: Ø2.6mm or Ø2.8mm
- * Finish: dark bronze

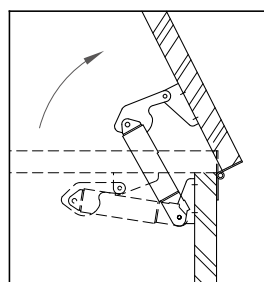
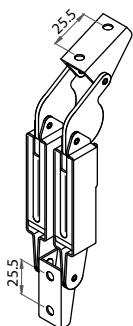

Item No.	Mounting
57597	back

